

Panasonic[®]

Operating Instructions

LCD Video Monitor

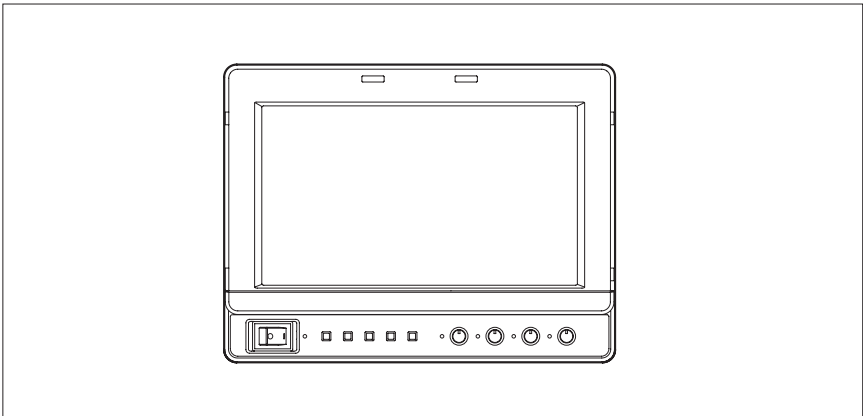

Model No. **BT-LH80WP**

Model No. **BT-LH80WE**



Before operating this product, please read the instructions carefully and save this manual for future use.

Read this first! (For BT-LH80WP)

	CAUTION RISK OF ELECTRIC SHOCK DO NOT OPEN	
<p>CAUTION: TO REDUCE THE RISK OF ELECTRIC SHOCK, DO NOT REMOVE COVER (OR BACK). NO USER SERVICEABLE PARTS INSIDE. REFER TO SERVICING TO QUALIFIED SERVICE PERSONNEL.</p>		

The lightning flash with arrowhead symbol, within an equilateral triangle, is intended to alert the user to the presence of uninsulated "dangerous voltage" within the product's enclosure that may be of sufficient magnitude to constitute a risk of electric shock to persons.



The exclamation point within an equilateral triangle is intended to alert the user to the presence of important operating and maintenance (service) instructions in the literature accompanying the appliance.



WARNING:

- TO REDUCE THE RISK OF FIRE OR SHOCK HAZARD, DO NOT EXPOSE THIS EQUIPMENT TO RAIN OR MOISTURE.
- TO REDUCE THE RISK OF FIRE OR SHOCK HAZARD, KEEP THIS EQUIPMENT AWAY FROM ALL LIQUIDS. USE AND STORE ONLY IN LOCATIONS WHICH ARE NOT EXPOSED TO THE RISK OF DRIPPING OR SPLASHING LIQUIDS, AND DO NOT PLACE ANY LIQUID CONTAINERS ON TOP OF THE EQUIPMENT.

CAUTION:

TO REDUCE THE RISK OF FIRE OR SHOCK HAZARD AND ANNOYING INTERFERENCE, USE THE RECOMMENDED ACCESSORIES ONLY.

FCC Note:

This equipment has been tested and found to comply with the limits for a class A digital device, pursuant to Part 15 of the FCC Rules. These limits are designed to provide reasonable protection against harmful interference when the equipment is operated in a commercial environment. This equipment generates, uses, and can radiate radio frequency energy, and if not installed and used in accordance with the instruction manual, may cause harmful interference to radio communications. Operation of this equipment in a residential area is likely to cause harmful interference in which case the user will be required to correct the interference at his own expense.

Warning:

To assure continued FCC emission limit compliance, the user must use only shielded interface cables when connecting to external units. Also, any unauthorized changes or modifications to this equipment could void the user's authority to operate it.

Notice (U.S.A. only):

This product has a fluorescent lamp that contains mercury. Disposal may be regulated in your community due to environmental considerations. For disposal or recycling information, please contact your local authorities, or the Electronics Industries Alliance:

<<http://www.eiae.org>>

CAUTION:

In order to maintain adequate ventilation, do not install or place this unit in a bookcase, built-in cabinet or any other confined space. To prevent risk of electric shock or fire hazard due to overheating, ensure that curtains and any other materials do not obstruct the ventilation.

CAUTION:

- Keep the temperature inside the rack to between 5 °C to 40 °C (41 °F to 104 °F).
- Bolt the rack securely to the floor so that it will not topple over.

 indicates safety information.

A rechargeable battery that is recyclable powers the product you have purchased.

Read this first! (For BT-LH80WE)

■ DO NOT REMOVE PANEL COVERS BY UNSCREWING THEM.

To reduce the risk of electric shock, do not remove the covers. No user serviceable parts inside.

Refer servicing to qualified service personnel.

WARNING:

- TO REDUCE THE RISK OF FIRE OR SHOCK HAZARD, DO NOT EXPOSE THIS EQUIPMENT TO RAIN OR MOISTURE.
- TO REDUCE THE RISK OF FIRE OR SHOCK HAZARD, KEEP THIS EQUIPMENT AWAY FROM ALL LIQUIDS. USE AND STORE ONLY IN LOCATIONS WHICH ARE NOT EXPOSED TO THE RISK OF DRIPPING OR SPLASHING LIQUIDS, AND DO NOT PLACE ANY LIQUID CONTAINERS ON TOP OF THE EQUIPMENT.

CAUTION:

TO REDUCE THE RISK OF FIRE OR SHOCK HAZARD AND ANNOYING INTERFERENCE, USE THE RECOMMENDED ACCESSORIES ONLY.

CAUTION:

In order to maintain adequate ventilation, do not install or place this unit in a bookcase, built-in cabinet or any other confined space. To prevent risk of electric shock or fire hazard due to overheating, ensure that curtains and any other materials do not obstruct the ventilation.

CAUTION:

- Keep the temperature inside the rack to between 5 °C to 40 °C.
- Bolt the rack securely to the floor so that it will not topple over.

 indicates safety information.

Attention/Attentie

ENGLISH

- Battery is used for the main power source in the product. At the end of their useful life, you should not throw them away. Instead, hand them in as small chemical waste.

NEDERLANDS

- Voor de primaire voeding van het apparaat wordt gebruikgemaakt van een batterij. Wanneer de batterij is uitgeput, mag u deze niet gewoon weggooien, maar dient u deze als klein chemisch afval weg te doen.



TO REMOVE THE BATTERY

Main Power Battery (Ni-Cd / Ni-MH / Li-ion Battery)

- To detach the battery, please proceed in the reverse order of the installation method described in this manual.
- If a battery made by any other manufacturer is to be used, check the Operating Instructions accompanying the battery.

Contents

Read this first! (For BT-LH80WP)	2	User Data	15
Read this first! (For BT-LH80WE)	3	Saving user data	15
Standard accessory	4	Loading user data	15
Optional unit	4	Main Menu	16
Precautions for use	5	Menu configuration	16
Outline	6	MARKER	17
Dimensions	6	Types of MARKER	18
Controls and Their Functions	7	VIDEO CONFIG	19
Front panel	7	SYSTEM CONFIG	21
Rear panel	8	VF CONFIG	22
Supplying the power	9	FUNCTION	23
Using the Anton/Bauer type battery pack	9	GPI	28
Using a V-mount type battery pack	9	INPUT SELECT	29
Using an external DC power supply	10	CONTROL	30
VF Function	11	HOURMETER	30
How to Use the On Screen Menu	12	REMOTE Specifications	31
Operating status display	12	GPI terminal	31
Picture adjusting knob status	12	RS-232C terminal	32
Sharpness display	13	RS-232C REMOTE operation method	32
Function display	13	Maintenance Inspections	35
DC power supply voltage and battery level display	13	Error/Warning Displays	36
Menu display	13	Maintenance	36
Menu operations	14	Specifications	36

Standard accessory

- Battery mount terminal block [2 screws (M3 x 4) included] × 1
- Screw spacer (already installed on the unit) × 1

Optional unit

- SDI input unit BT-YA80G
- VF Cable Set BT-CS80G
(DC cable also included → page 11)

Precautions for use

This product has been specially designed for commercial use. As such, it should be used and operated only by persons with related expertise.

- The liquid crystal parts are fabricated using high-precision technology. The screen has effective pixels that cover more than 99.99% of its area, but pixels may be missing or remain permanently lighted (red, blue and/or green) in less than 0.01% of the area. This is not indicative of malfunctioning.
- The panel which protects the liquid crystal display has been specially treated.
Do not wipe it with hard cloths or rub it heavily as this will damage the surface of the panel.
- If a still image is displayed continuously for a long period of time, the image may be burnt onto the screen for some time.
(The shadow of the image will usually disappear after moving images are displayed for while.)
- The response speed and brightness of the liquid crystals will vary with the surrounding temperature.
- Do not expose the liquid crystal display to strong light, as it could cause a deterioration in the display characteristics and reduce the display quality.
- Do not keep in an environment where the temperature changes suddenly, because condensation could form on the surface of the liquid crystal or in the internal parts and cause a reduction in the display quality or a malfunction.
- Screen irregularities may be generated when certain images are displayed.
- If the unit is left for a long time in a location with a high temperature or humidity, it could change the characteristics of the liquid crystal panel and cause irregularities.

Outline

The BT-LH80W is a thin and lightweight liquid crystal monitor designed especially for broadcasting service and business use. It is equipped with a 7.9-inch V (effective display area) liquid crystal display panel. It can be used as a VF (viewfinder) for broadcasting and business cameras made by Panasonic.

■ Equipped with a new IP conversion circuit, the circuit processing greatly reduces time delays

A new I/P conversion circuit has been introduced that converts and generates SD and HD interlace signals to high-precision progressive signals without generating time delays per field.

■ Equipped with a diagonal line correction processing circuit

By detecting correlations in the field in the diagonal direction in addition to the vertical direction, the unit performs the optimum interpolation to minimize the rough noise occurring in the diagonal direction and create a smooth image.

■ New functions that support focus adjustments

• FOCUS-IN-RED function

The section of the image that is being focused is displayed in an easy-to-understand red, making camera focus adjustments very easy.

• PIXEL TO PIXEL function

The input signal is displayed without being resized, greatly facilitating camera focus adjustments.

If you are not resizing the image, you can check the image by expanding a 1080/60i signal to the equivalent of an image approximately 19 inches wide.

■ Thin, lightweight, compact and low energy consumption

The unit has a compact body that makes the most of the thin and lightweight characteristics of LCD panels, with a depth of 64.7 mm (2-9/16 inches) and a weight of 1.5 kg (3.3 lb).

Further, it is compatible with HD and has low energy consumption.

Dimensions

Unit: mm (inches)

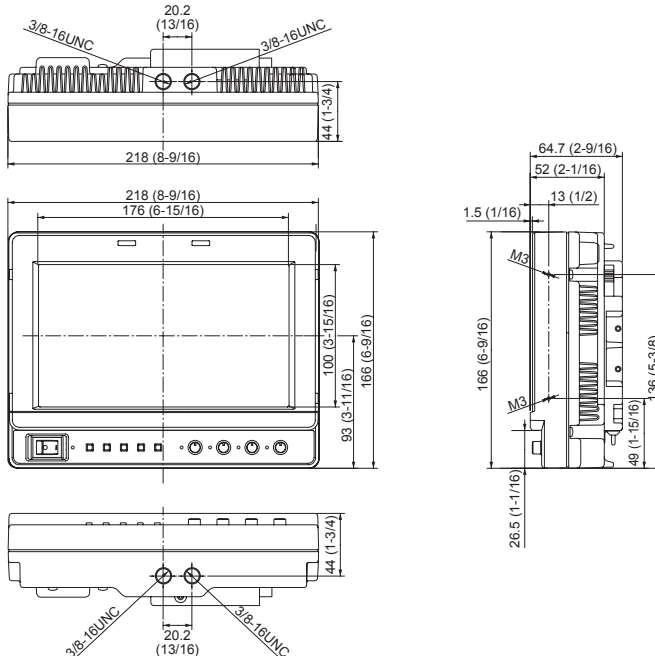

Controls and Their Functions

Front panel

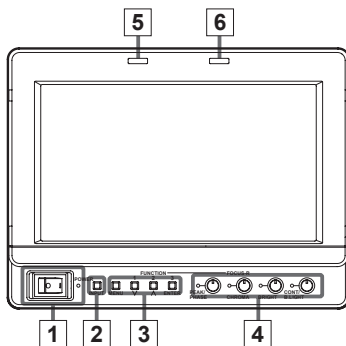

1 POWER switch/lamp

This switches the power supply ON/OFF. When the power is ON, the LED (green) lights up.

2 INPUT SELECT button

This selects the signal input line. Each time the button is pressed, the input changes in the following order:
YP_BP_R → VF-YP_BP_R/VF-VIDEO → VIDEO → SDI.

YP_BP_R : Analog component input

VF-YP_BP_R / VF-VIDEO*1 : Viewfinder input

VIDEO : Video input

SDI*2 : Serial digital interface input (compatible with HD/SD)

- The input line when the power supply is switched ON is the one that was selected the last time the power was switched OFF. The INPUT menu settings can be used to skip input lines that are not used.

- When the control lock is on, input lines cannot be selected.

*1 The menu is used to set either YP_BP_R or VIDEO for the viewfinder input.

*2 Can only be selected when the separately sold BT-YA80G is installed.

3 MENU and FUNCTION buttons

These are used for menu display, selecting settings and adjustments, and for carrying out the items selected in the menu.

MENU : Push to display or exit the menu, or to return to the previous menu screen.

∨ / FUNCTION1 : Push to move the cursor down and select an item.

In addition, FUNCTION1 carries out the item selected in the menu.

∧ / FUNCTION2 : Push to move the cursor up and select an item.

In addition, FUNCTION2 carries out the item selected in the menu.

ENTER / FUNCTION3 : Push to confirm a setting, or to display a submenu.

In addition, FUNCTION3 carries out the item selected in the menu.

- When the control lock is on, the key mark appears and FUNCTION operations cannot be executed.

4 Picture adjusting knobs/lamps

PEAK [PEAKING] 0 - 30(0) / PHASE 0 - 60(30)

CHROMA 0 - 60(30) / FOCUS-R(→page 27) 0 - 30(25)

BRIGHT 0 - 60(30)

CONT [CONTRAST] 0 - 60(50) / B.LIGHT [BACKLIGHT] 0 - 60(60) () denotes factory preset values

A rotating knob that can be pushed to operate. When the picture adjusting knob is pressed, its status is displayed and adjustment becomes possible. The setting values are saved by pushing the knob again.

When values are changed from the factory preset values, the LEDs to the side of knobs (amber) light.

The setting values are loaded when the monitor's power is switched ON. The setting values are saved when the knob is pushed, or when 10 seconds pass after changing the settings. However, operating changes cannot be made in the following cases.

- When the control lock is on, the key mark appears and setting values cannot be changed.

- Only items selected in the menu can be adjusted for PEAK/PHASE and CONT/B. LIGHT.

- When the MONO function is ON, PHASE and CHROMA operations are disabled.

- FOCUS-R is enabled during operations of the FOCUS-IN-RED function.

- During BLUE ONLY, the PEAK/PHASE knob functions as PHASE.

5 R-TALLY (red)

Can be lit by a control signal from a GPI/camera.

6 G-TALLY (green)

Can be lit by a control signal from a GPI/camera.

Controls and Their Functions (continued)

Rear panel

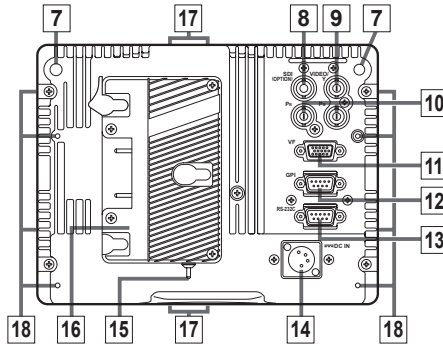

- 7 REAR TALLY (red)**
Can be lit by a control signal from a GPI/camera.
- 8 SDI (HD/SD) input terminal (BNC) - option**
This is the SDI input terminal. (Compatible with HD/SD automatic switching)
• If you want this input, contact the vendor where you purchased the unit.
- 9 VIDEO/Y input terminal (BNC)**
This is the VIDEO signal (component signal) input terminal/Y input terminal.
- 10 PaPr input terminal (BNC)**
This is the PaPr signal (analog component signal) input terminal.
- 11 VF terminal (D-SUB, 15 pins)**
This terminal connects to the VF (viewfinder) terminal of broadcasting and business cameras made by Panasonic.
The unit can be used as the viewfinder for such a camera.
- 12 GPI input terminal (D-SUB, 9 pins)**
External control is possible by using a GPI signal.
- 13 RS-232C terminal (D-SUB, 9 pins)**
External control is possible by using an RS-232C interface.
- 14 DC IN terminal (XLR, 4 pins)**
This is the external DC power supply input terminal.
When a DC power supply is connected concurrently with the battery, the external power input takes precedence.
- 15 Light control switch**
This is not used on this monitor.
- 16 Battery holder**
This holder is used with a battery made by Anton/Bauer.
- 17 Screw holes for tripod fixing**
There are two screw holes on both the top and bottom for fixing the unit to a tripod (compatible with 3/8-16UNC). In addition, removable screw spacers are installed in one of the screw holes on the bottom of the unit, which are compatible with 1/4-20UNC screws. Use the size that matches the diameter of the tripod's fixing screw.
- 18 Screw holes for fixing**
There are four screw holes (M3) for fixing the mounter on the rear of the unit, two each on the left and right.

Supplying the power

An Anton/Bauer or V-mount type of battery pack or an external DC power supply can be used to power this monitor.

Using the Anton/Bauer type battery pack

1. Install the Anton/Bauer type of battery pack.

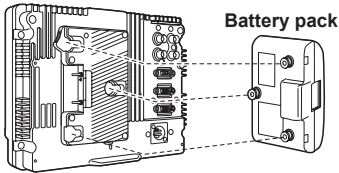

2. Insert the battery pack and slide it in the direction of the arrow.

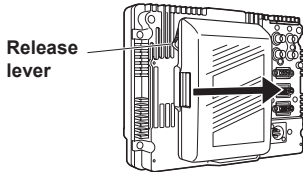

<Reference>

To remove the battery pack, slide it in the opposite direction to the one in which it was attached while keeping the release lever on the battery holder pulled down all the way.

Using a V-mount type battery pack

CAUTION:

These servicing instructions are for use by qualified service personnel only. To reduce the risk of electric shock, do not perform any servicing other than that contained in the operating instructions unless you are qualified to do so.

1. Remove the battery holder.

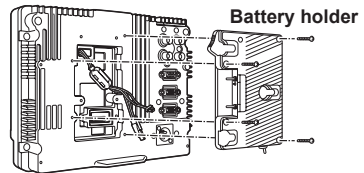

2. Install the accessory battery mount terminal block.

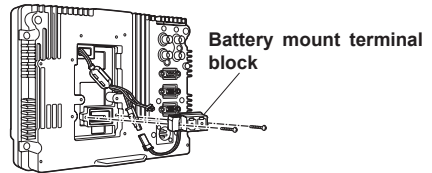

3. Fix the V-mount type battery holder with four screws (length 8 mm (5/16 inch)) supplied with the holder, and then fasten the two screws on the terminal section.

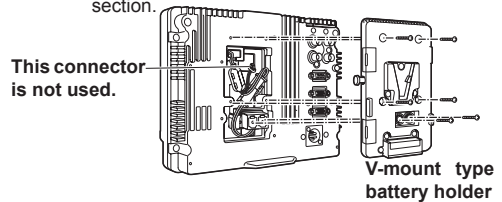

Supplying the power (continued)

Using an external DC power supply

1. Connect the external DC power supply to the DC IN socket on this unit.

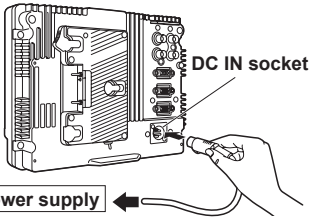

2. Turn "ON" the external DC power supply switch. (Where the external DC power supply has a power switch)

3. Turn "ON" the POWER switch on this unit.

If an external DC power supply is used, then check the ratings of the external DC power supply so that they are compatible with those of this unit.

Check the pin arrangements of the DC output terminal of the external DC power supply and those of the DC IN socket of this unit so that their polarities are correctly arranged.

If +12 V are supplied to the unit's GND terminal by mistake, this may cause fire or injury.

DC IN socket

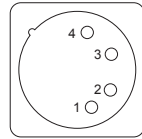

1: GND
4: +12 V

<Notes>

- Use a shield cable with a length of 2 m (6.56 feet) or less for the DC cable. Use of cords any longer than 2 m (6.56 feet) may result in noise appearing on the screen.
- If the battery pack and an external DC power supply are connected simultaneously, then the external DC power supply will have priority. If the external DC power supply is used, then the battery pack may be fitted or removed.
- If an external DC power supply is used, then make sure that the external DC power supply is first turned ON, then this unit is turned ON. If they are turned ON in the reverse order, then this unit may malfunction, because the output voltage of the external DC power supply will gradually increase.
- Input voltage that above the specification is not displayed accurately.

VF Function

The unit can be connected to broadcasting and business cameras made by Panasonic and used as a VF (viewfinder).

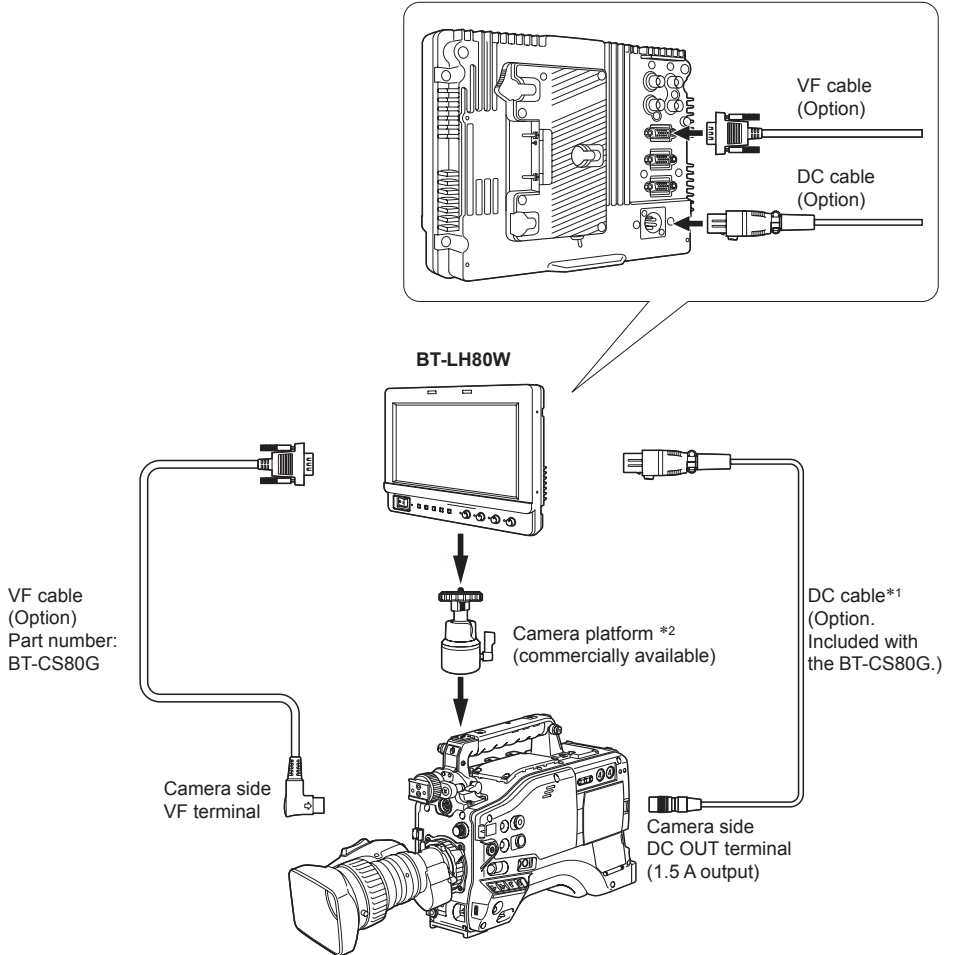

*1 Broadcasting and business camera-recorders compatible with a DC power supply (output current of 1.5 A)
AJ-HDC27H
AJ-HDX900
AJ-HPX2000 / 2100
AG-HPX500 / 502

Other cameras or camera-recorders cannot be used because they have an output current of 1 A or 0.1 A.
Use a battery or external DC power supply.

Contact your vendor for details of broadcasting and business camera-recorders that will be launched in the future.

*2 Use a camera platform that can fully withstand the weight of the unit (1.5 kg (3.3 lb)).

How to Use the On Screen Menu

Six types of information are displayed on the screen: the operating status display, picture adjusting knob status, sharpness display, function display, DC power supply voltage display, battery level display and menu display.

Operating status display

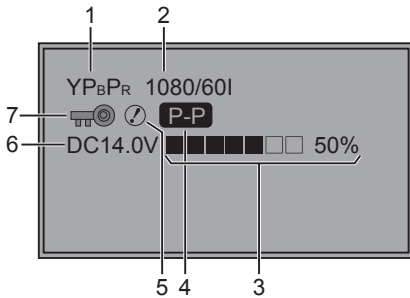

1. The selected input line (→ page 7, 2)

- YPbPr, VF-YPbPr/VF-VIDEO, VIDEO, SDI

2. Signal format

- The display status can be set in "STATUS DISPLAY" in the "SYSTEM CONFIG" menu (→ page 21).
- If "UNSUPPORT SIGNAL" is displayed, then either the current input signal is not supported or the "INPUT SELECT" menu setting needs to be changed.
- When "NO SIGNAL" is displayed, there is no input signal.

3. Battery level display

- When an Anton/Bauer type digital battery is used, battery level is displayed using a block count (■) and percentage.

4. Various displays (PIXEL TO PIXEL mode)

- Displayed when the picture display is PIXEL TO PIXEL.

5. Various displays (warning of improper operation status for the camera settings)

- Displayed when there is an improper operation status relative to the camera settings.

6. DC power supply voltage display

- DC power supply voltage is displayed.

7. Various displays (lock setting)

- Displayed when front operations are locked (→ page 30).

<Note>

"UNSUPPORT SIGNAL" and "NO SIGNAL" may not be displayed correctly.

Picture adjusting knob status



Picture adjusting knob (→ page 7, 4)

- This knob can be rotated and pushed.
- The status display appears when the knob is pushed. The display disappears when the knob is pushed again, or if the knob is not operated for 10 seconds.
- The settings can be adjusted while this display is shown, but the settings cannot be adjusted after the display disappears.

Status display:

PEAKING or PHASE
CHROMA or FOCUS-IN-RED
BRIGHT
CONTRAST or BACKLIGHT

How to Use the On Screen Menu (continued)

Sharpness display

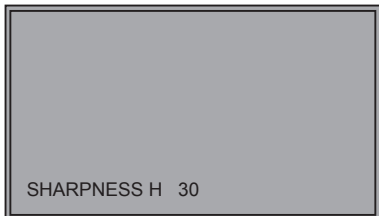

- SHARPNESS H/V is displayed when it is set.
- The display disappears if remains idle for 2 minutes.

Function display

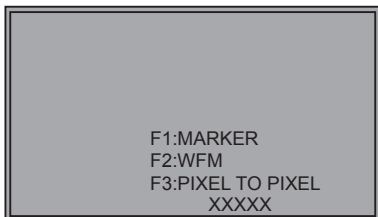

- You can set FUNCTION display in the menu.
- When "FUNCTION DISPLAY" (→ page 23) is ON1 or ON2 and one of the buttons from [FUNCTION1] to [FUNCTION3] is pressed, the unit displays the status of the FUNCTION item that is set.
- The display disappears if remains idle for 2 seconds.
- The operational status is displayed in "XXXXX" (→ page 24 "Operation status displayed when a FUNCTION button is used").

DC power supply voltage and battery level display

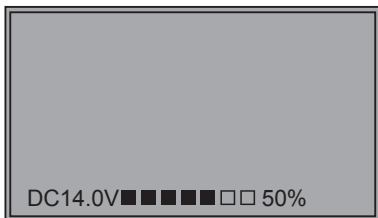

- DC power supply voltage is displayed.
- Battery level is displayed when using an Anton/Bauer type digital battery.
- Displayed when the operating status display is not displayed.

Menu display

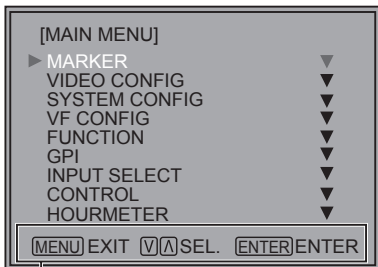

- This is displayed when the menu is used.
- The display disappears if remains idle for 2 minutes.

Displays the operation explanation for the menu button.

How to Use the On Screen Menu (continued)

Menu operations

1. Push [MENU] to display the MAIN menu.

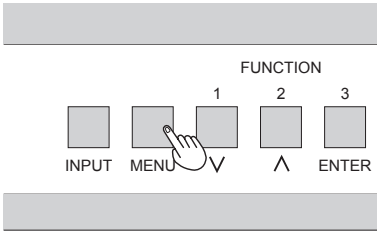

2. Push [V, ^] to select the menu, then push [ENTER].

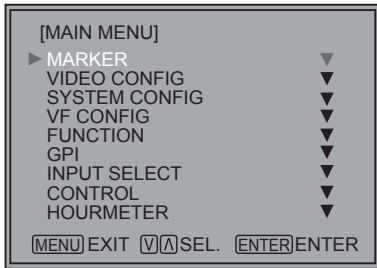

3. Push [V, ^] to select the sub menu, then push [ENTER].

The setting values in the sub menu change to green.

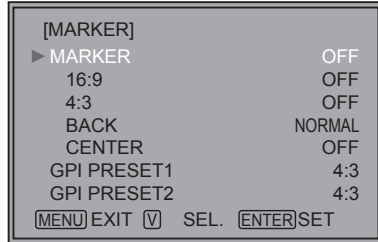

4. Push [V, ^] to select the setting values, then push [ENTER].

Push [MENU] to cancel.

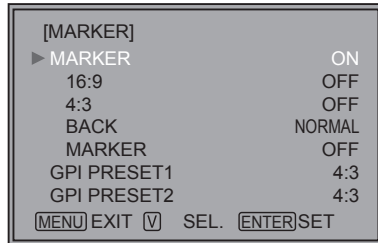

To return to the previous screen

Push [MENU].

User Data

You can change the menu setting values and picture adjusting knob settings, then save and load up to 5 combinations of screen adjustment values as user data. You can also return the setting values and adjustment values to the factory preset settings.

The following settings are included in user data.

- Menu settings except for “SETUP LOAD/SAVE” and “REMOTE of CONTROL” (including the button function settings on the front of the monitor)
- Screen adjustment values changed in picture adjusting knob

Saving user data

1. Push [MENU] to display the MAIN menu.
2. Push [V, ^] to select the “SYSTEM CONFIG” menu and push [ENTER].
3. Push [V, ^] to select the “SETUP SAVE” sub menu and push [ENTER].

The setting values in the sub menu change to green.

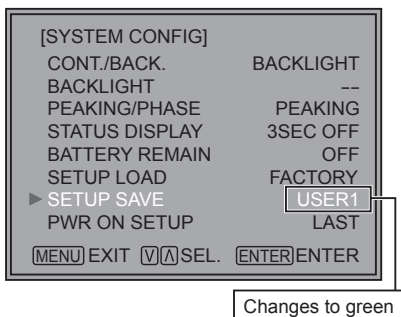

4. Push [V, ^] to select the file you wish to save to from “USER1” – “USER5”, then push [ENTER].

The following screen appears.

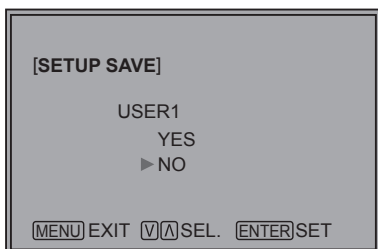

5. Select “YES”, and push [ENTER].

The user data is saved.

Loading user data

1. Push [MENU] to display the MAIN menu.
2. Push [V, ^] to select the “SYSTEM CONFIG” menu and push [ENTER].
3. Push [V, ^] to select the “SETUP LOAD” sub menu and push [ENTER].

The setting values in the sub menu change to green.

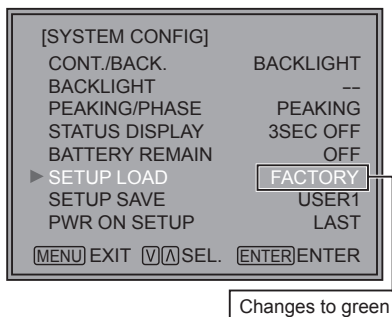

4. Push [V, ^] to select the file you wish to load to from “USER1” – “USER5”, then push [ENTER].

The following screen appears.

To return to the factory preset setting values, select “FACTORY”.

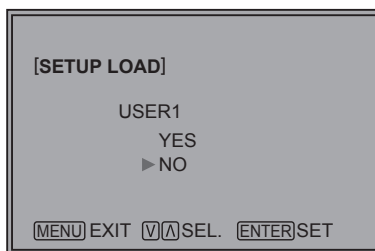

5. Select “YES”, and push [ENTER].

The user data is loaded.

To return to the previous screen

Push [MENU].

Main Menu

Menu configuration

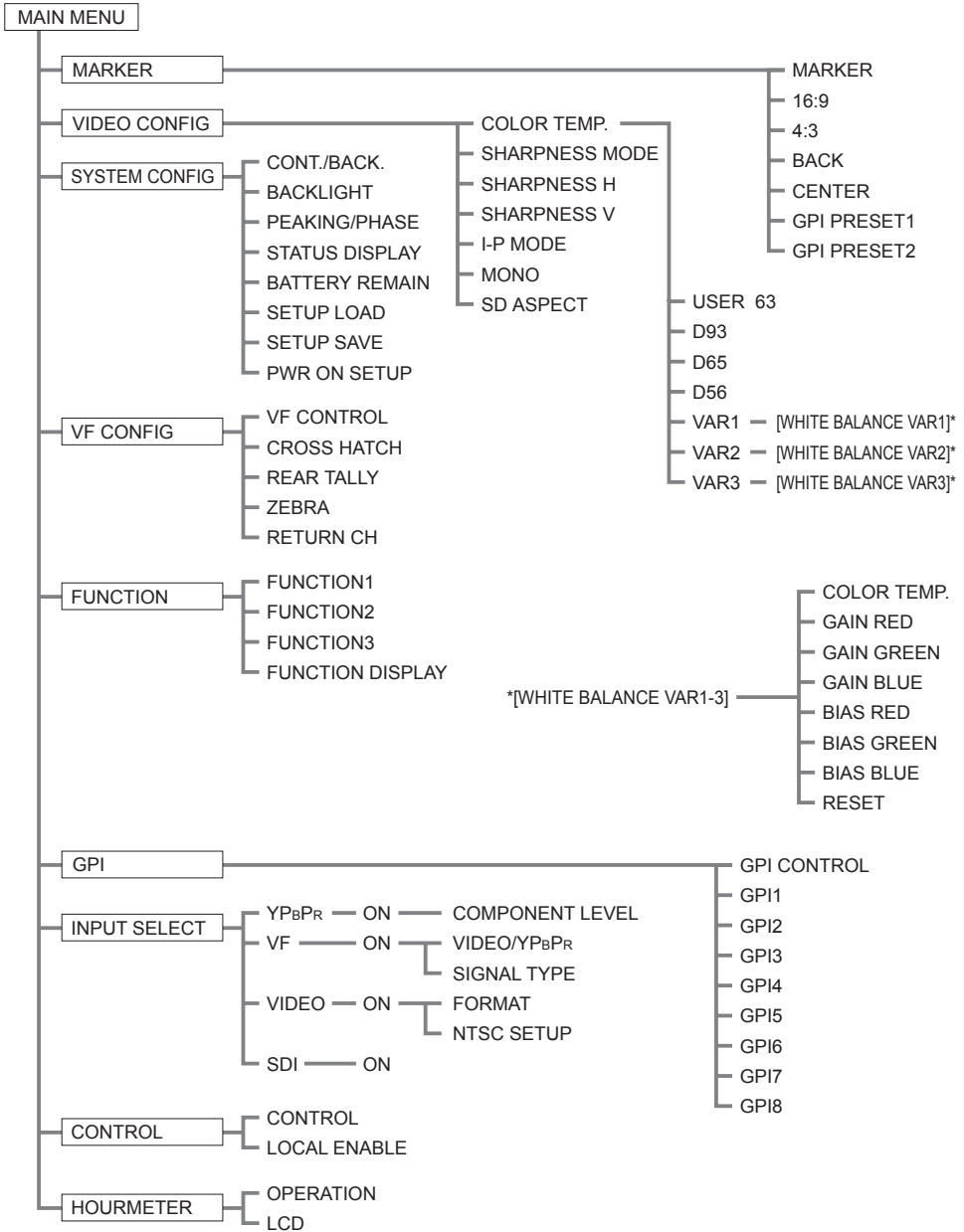

Main Menu (continued)

MARKER

The underlined values are factory preset setting values.

Sub menu	Settings	Explanation
MARKER	OFF*1 ON	Used to make MARKER settings effective.
16:9*2*3	OFF <u>4:3</u> 13:9 14:9 CNSCO VISTA 95% 93% 90% 88% 80%	Used to select/display the type of marker when the aspect ratio setting is 16:9. <OFF> Marker not displayed. <4:3> 4:3 marker <13:9> 13:9 marker <14:9> 14:9 marker <CNSCO> CNSCO marker <VISTA> VISTA marker <95%> 95% Area marker <93%> 93% Area marker <90%> 90% Area marker <88%> 88% Area marker <80%> 80% Area marker
4:3*2	OFF 95% <u>93%</u> 90% 88% 80%	Used to select/display the type of 4:3 marker. <OFF> Marker not displayed. <95%> 95% Area marker <93%> 93% Area marker <90%> 90% Area marker <88%> 88% Area marker <80%> 80% Area marker
BACK*2	<u>NORMAL</u> HALF BLACK	Used to select the background brightness excluding the marker. <NORMAL> Normal background <HALF> Background brightness 50% <BLACK> Background brightness 0% (Black)
CENTER*2	OFF ON	Used to display the center marker. <OFF> Not displayed <ON> Displayed
GPI PRESET1*4	4:3 13:9 14:9 CNSCO VISTA	GPI PRESET1: Used to select the marker to be displayed using the GPI terminal "MARKER1 ON/OFF" operation (→ page 31). GPI PRESET2: Used to select the marker to be displayed using the GPI terminal "MARKER2 ON/OFF" operation (→ page 31). <4:3> 4:3 marker <13:9> 13:9 marker <14:9> 14:9 marker <CNSCO> CNSCO marker <VISTA> VISTA marker <95% (16:9)> 95% Area marker when the aspect ratio is 16:9. <93% (16:9)> 93% Area marker when the aspect ratio is 16:9. <90% (16:9)> 90% Area marker when the aspect ratio is 16:9. <88% (16:9)> 88% Area marker when the aspect ratio is 16:9. <80% (16:9)> 80% Area marker when the aspect ratio is 16:9. <95% (4:3)> 95% Area marker when the aspect ratio is 4:3. <93% (4:3)> 93% Area marker when the aspect ratio is 4:3. <90% (4:3)> 90% Area marker when the aspect ratio is 4:3. <88% (4:3)> 88% Area marker when the aspect ratio is 4:3. <80% (4:3)> 80% Area marker when the aspect ratio is 4:3.
GPI PRESET2*4	<u>95% (16:9)</u> 95% (4:3) 93% (16:9) 93% (4:3) 90% (16:9) 90% (4:3) 88% (16:9) 88% (4:3) 80% (16:9) 80% (4:3)	

- The marker is not displayed during VF line operation.
- The marker display size is the display size of a camera-recorder, and so is smaller than the previous model (BT-LH900A).
- *1 The setting becomes "ON" when the unit receives marker-related control during REMOTE operation. (Priority goes to GPI when GPI settings exist.)
- *2 When controlling the marker settings using the GPI function (→ page 31), these settings become disabled.
- *3 These are only enabled when the HD signal and SD signal aspect ratio settings are 16:9.
- *4 When the HD signal and SD signal aspect ratio setting is 16:9, a 4:3 marker is displayed in the center 4:3 area.

Types of MARKER

■ 16:9 marker

(Displayed when using HD, or when using SD with a 16:9 aspect ratio)

The marker is only displayed as a vertical bar. In addition, the  section becomes the "MARKER BACK" item.

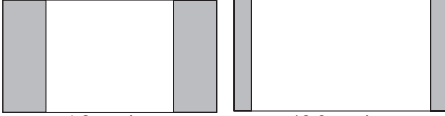

4:3 marker

13:9 marker



14:9 marker

VISTA marker, CNSCO marker

A horizontal dotted line is displayed as the marker.

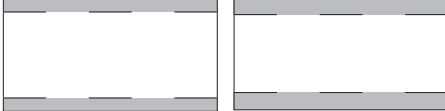

VISTA marker

CNSCO marker

Area marker

A dotted line is displayed as the marker.

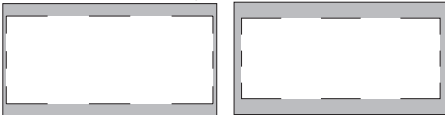

95% Area marker

93% Area marker

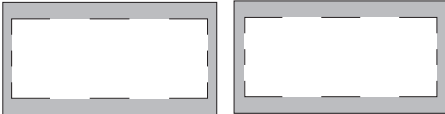

90% Area marker

88% Area marker



80% Area marker

■ 4:3 marker

(Displayed when using SD with a 4:3 aspect ratio)

A dotted line is displayed as the marker.



95% Area marker

93% Area marker



90% Area marker

88% Area marker

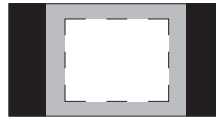

80% Area marker

(Displayed when using HD, or when using SD with a 16:9 aspect ratio)

A dotted line is displayed as the marker.

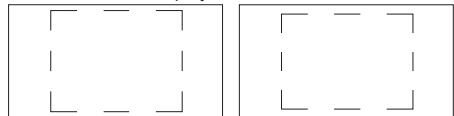

95% Area marker

93% Area marker

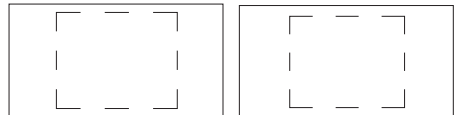

90% Area marker

88% Area marker

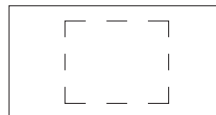

80% Area marker

* You can display 4:3 marker at the same time as 16:9 marker.

Simultaneously display example

The  section becomes the "MARKER BACK" item. The background selected with the 16:9 marker is controlled.

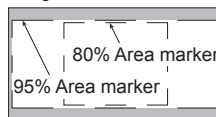

16:9 marker:

95% Area marker

4:3 marker:

80% Area marker

■ Center marker

Center marker

The marker is displayed in the center of the picture.

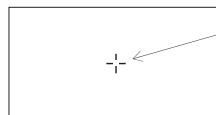

Main Menu (continued)

VIDEO CONFIG

The underlined values are factory preset setting values.

Sub menu	Settings	Explanation
COLOR TEMP.	USER 63* ¹ D93 <u>D65</u> D56 VAR1 VAR2 VAR3	Used to select the color temperature. <USER 0 - 63> Adjustable settings 0 - 63 (color temperature around 3000K - 9300K) <D93> Color temperature around 9300K <D65> Color temperature around 6500K <D56> Color temperature around 5600K <VAR1> WB adjustment mode* ² <VAR2> WB adjustment mode* ² <VAR3> WB adjustment mode* ²
SHARPNESS MODE	HIGH* ³ LOW	Used to select the width of the sharpness edge. <HIGH> Thin edge <LOW> Thick edge
SHARPNESS H	0 - 30* ³	Used to set the sharpness in the horizontal direction. When adjusting, the item display moves to the lower part of the screen.
SHARPNESS V	0 - 30* ³	Used to set the sharpness in the vertical direction. When adjusting, the item display moves to the lower part of the screen.
I-P MODE	MODE2 <u>MODE1</u>	Used to select IP conversion mode. (→ page 20 "About IP Mode") <MODE2> Field Interpolation <MODE1> Frame Interpolation
MONO*⁴	OFF ON	Used to switch between color and monochrome (MONO). <OFF> Color <ON> Monochrome * When this is ON, the picture adjusting knob [CHROMA] setting is fixed at 0.
SD ASPECT*⁴	4:3 16:9	Used for setting the aspect ratio settings when using SD signal input. <4:3> 4:3 display <16:9> 16:9 display

*1 When selecting USER 0 - 63

1) Push [ENTER] (USER changes to blue). 2) Select 0 - 63 with [V, ^], and push [ENTER].

*2 When "VAR1", "VAR2" or "VAR3" is selected, the monitor switches to WB adjustment mode (→ page 20).

*3 The following sharpness values can each be set,

1) VIDEO system input line (VIDEO)(Factory settings are SHARPNESS MODE: LOW, SHARPNESS H/V: 0)

2) any other input line's HD (Factory settings are SHARPNESS MODE: HIGH, SHARPNESS H/V: 0)

3) any other input line's SD (Factory settings are SHARPNESS MODE: LOW, SHARPNESS H/V: 0)

and the setting values for the selected input signal from within this group is displayed. The adjustment status is displayed in the bottom right when selected.

*4 During GPI control, the setting items are displayed in gray and the display changes in accordance with the GPI control.

Main Menu (continued)

About IP Mode

By selecting "MODE1", you can convert IP through Frame Interpolation.

This unit has reduced the Frame Interpolation delay to 1 field or less, compared to our old models having caused 1 frame delay or more.

Factory preset setting value is "MODE1" recommended for normal use. Depending on images, in very rare cases, noise may occur on the screen. In such a case, "MODE 2" is recommended.

By selecting "MODE2", you can convert IP through Field Interpolation.

Since MODE2 interpolates only within each Field, it is suitable to confirm interlace condition.

Depending on still images, etc., flickers may occur on the screen. In such a case, "MODE1" is recommended.

■ WB adjustment mode

You can adjust "WHITE BALANCE VAR1" - "WHITE BALANCE VAR3" (WB) by selecting "VAR1" - "VAR3" in "COLOR TEMP." in the "VIDEO CONFIG" menu.

The underlined values are factory preset setting values.

Sub menu	Settings	Explanation
COLOR TEMP.*1	USER 0 - 63 D93 D65 D56	Used to select the color temperature that will become the basis for adjustments. <USER 0 - 63>Adjustable settings 0 - 63 (color temperature around 3000K - 9300K) <D93> Color temperature around 9300K <D65> Color temperature around 6500K <D56> Color temperature around 5600K
GAIN RED	0 - 511	GAIN elements for RED are adjusted.*2
GAIN GREEN	(Factory presets are values for color temperature <D65>.)	GAIN elements for GREEN are adjusted.*2
GAIN BLUE	* The presets are values adjusted before shipment from factories.	GAIN elements for BLUE are adjusted.*2
BIAS RED	-512 - 511	BIAS elements for RED are adjusted.*2
BIAS GREEN	(Factory preset settings: 0)	BIAS elements for GREEN are adjusted.*2
BIAS BLUE		BIAS elements for BLUE are adjusted.*2
RESET		"GAIN RED" - "BIAS BLUE" values are reset to color temperatures values selected in "COLOR TEMP."

*1 When "COLOR TEMP." is selected and [ENTER] is pressed following item change, the display changes to the confirmation screen. Selecting "YES" and pressing [ENTER] on this screen return GAIN and BIAS values to the selected color temperature values.

*2 When adjusting, the item display moves to the lower part of the screen.

Main Menu (continued)

SYSTEM CONFIG

The underlined values are factory preset setting values.

Sub menu	Settings	Explanation
CONT. /BACK.	<u>BACKLIGHT</u> CONTRAST	Used to select the function to be assigned to CONT/B.LIGHT (a knob on the front panel). <BACKLIGHT> Used to adjust BACKLIGHT. <CONTRAST> Used to adjust CONTRAST.
BACKLIGHT	0 - <u>60</u>	Used to adjust the LCD backlight level. <Note> CONT./BACK displays "-" while BACKLIGHT settings are performed.
PEAKING/PHASE	<u>PEAKING</u> PHASE	Used to select the function to be assigned to PEAK/PHASE (a knob on the front panel). <PEAKING> Assigns to the PEAKING function. <PHASE> Assigns to the PHASE function.
STATUS DISPLAY	CONTINUE <u>3SEC OFF</u> *1 OFF	Used to set the display time for the status display. <CONTINUE> Always displayed. <3SEC OFF> Displayed for 3 seconds. <OFF> Not displayed.
BATTERY REMAIN	<u>OFF</u> ON	Used to select whether or not to display the battery level. <OFF> Not displayed. <ON> Displayed.
SETUP LOAD	<u>FACTORY</u> USER1 USER2 USER3 USER4 USER5	Used to load the saved factory preset setting values (FACTORY) or user data (USER 1 - USER 5). <FACTORY> The factory preset settings. <USER1 - 5> The saved USER data *2. When the unit is shipped from the factory, the USER 1 to 5 data items are the same as the factory preset values.
SETUP SAVE	<u>USER1</u> USER2 USER3 USER4 USER5	Used to save user data. Up to 5 sets of user data can be saved, which include the current setting values for the menu and picture adjusting knobs.
PWR ON SETUP	<u>LAST</u> FACTORY USER1 USER2 USER3 USER4 USER5	Used to select the settings for when the power supply is switched ON. <LAST> Starts up with same settings as the last time the power supply was switched OFF. <FACTORY> Starts up with the FACTORY settings. <USER1 - 5> Starts up with the settings that are saved in a USER item.

*1 Functions as CONTINUE when  (warning of improper operation status for the camera settings) is displayed or when the  (PIXEL TO PIXEL) status is displayed.

*2 USER saving is not possible when CONTROL is set to REMOTE.

Main Menu (continued)

VF CONFIG

The underlined values are factory preset setting values.

Sub menu	Settings	Explanation
VF CONTROL	<u>VF-CH</u> ALL-CH	Used to select the input line for the VF function of the monitor. (VF function: tally lamp lit, zebra displayed,  displayed) <VF-CH> Only enabled when the VF line is selected. <ALL-CH> Enabled with all input lines.
CROSS HATCH	HIGH LOW <u>OFF</u>	Used to set whether to display a cross hatch and select its density level. <HIGH> 70/256 (displays with a dense cross hatch) <LOW> 20/256 (displays with a light cross hatch) <OFF> Not displayed.
REAR TALLY	<u>ON</u> OFF	Used to allow control of the tally lamp on the rear of the monitor. <ON> Lamp lights when TALLY control from a GPI/camera is ON. <OFF> Lamp does not light.
ZEBRA	ON <u>OFF</u>	Used to set ZEBRA information in the camera. <ON> Sets the information to ON. <OFF> Sets the information to OFF.
RETURN CH*1*2	<u>YP&PB</u> VF VIDEO SDI	Used to select the signal input line by operating the RETURN (RET) button of the camera lens. <Note> When there is no SDI input unit (option), the SDI item is displayed in gray and cannot be set.

• The priority sequence for GPI control and RS-232C is as follows: GPI > VF CONFIG > RS-232C.

*1 RETURN CH operates when VF CONTROL is set to ALL-CH. It is not affected by the various line ON/OFF settings in the INPUT SELECT menu (→ page 29). (Input lines that are set with RETURN CH are enabled even if they are set to OFF in INPUT SELECT.)

*2 A function to be used with future Panasonic camera-recorders.

Main Menu (continued)

FUNCTION

The underlined values are factory preset setting values.

Sub menu	Settings	Explanation
FUNCTION1 - 3	BLUE ONLY SD ASPECT* <u>1</u> *2 WFM MARKER* <u>1</u> *3 PIXEL TO PIXEL *4 PIXEL POS. +*5 PIXEL POS. -*5 FOCUS-IN-RED *4*7 ZEBRA REAR TALLY*6 CROSS HATCH MONO*1 UNDEF (Factory preset setting→ FUNCTION1: WFM FUNCTION2: PIXEL TO PIXEL FUNCTION3: FOCUS-IN-RED)	Used to select the functions to be assigned to individual buttons [FUNCTION1] to [FUNCTION3] (front-panel buttons). <BLUE ONLY> Used to cut the red and green signals. You can check the hue (PHASE) and depth of color (CHROMA). This is switched between ON/OFF by pushing the button. <SD ASPECT> Used to switch between "16:9" and "4:3". <WFM> Used to display the waveform display screen. <MARKER> Used to display the marker. <PIXEL TO PIXEL> Used to switch the screen display between input size and display size. <PIXEL POS.+> During PIXEL TO PIXEL display, used to move the signal display position clockwise and display it. <PIXEL POS.-> During PIXEL TO PIXEL display, used to move the signal display position counterclockwise and display it. <FOCUS-IN-RED> Used to highlight in red the section of the image that is being focused. <ZEBRA> Used to set the zebra display ON or OFF for the camera. <REAR TALLY> Used to set the rear tally ON or OFF. <CROSS HATCH> Used to display a cross hatch. <MONO> Used to switch the display between color and black-and-white. <UNDEF> Undefined.
FUNCTION DISPLAY*8	<u>ON1</u> ON2*9 OFF	Used to display the functions assigned from [FUNCTION1] to [FUNCTION3] (buttons on the front panel). The button action can also be selected (1-touch, 2-touch, OFF). <ON1> Function display and function operation can be performed with one touch. <ON2> Function display and function operation can be performed with two touches. <OFF> Function not displayed.

• If a FUNCTION button is pushed during the picture adjusting knobs display, the picture adjusting knobs display will be cancelled and the FUNCTION operation cannot be executed.

*1 The control settings do not operate during GPI operation.

*2 If these settings are changed, the menu settings will also change.

*3 Not displayed when 16:9, 4:3, BACK and CENTER are all OFF in the MARKER menu settings.

*4 SD ASPECT cannot be switched when PIXEL TO PIXEL is ON during SD display.

*5 PIXEL POSITION is not backed up. It is always CENTER when the power supply is switched ON.

*6 Only enabled when TALLY control from the camera is ON.

*7 During FOCUS-IN-RED operation, the detection sensitivity can be changed with the FOCUS-R knob.

The setting range is from 0 to 30, with 30 the most sensitive detection.

*8 The operating status is displayed regardless of the ON/OFF setting.

*9 The function displayed with the ON2 setting can be operated with a button only during the time that it is displayed.

Main Menu (continued)

■ Restrictions on various FUNCTION settings

Under the following conditions, various settings are disabled.

Setting	Disabling condition
SD ASPECT	Does not operate while GPI items are being set. Does not operate during PIXEL TO PIXEL operation. Does not operate during HD display. If operated during the conditions described above, "INVALID FUNCTION" is displayed.
WFM	Does not operate during PIXEL TO PIXEL or FOCUS-IN-RED mode. If operated during the conditions described above, "INVALID FUNCTION" is displayed.
MARKER	Does not operate while GPI items are being set. Does not operate when the VF line is selected for the input. Does not operate during PIXEL TO PIXEL or FOCUS-IN-RED mode. If operated during the conditions described above, "INVALID FUNCTION" is displayed.
PIXEL TO PIXEL	Does not operate while WFM is ON or GPI items are being set. If operated during the conditions described above, "INVALID FUNCTION" is displayed.
FOCUS-IN-RED	Does not operate while WFM is ON or GPI items are being set. If operated during the conditions described above, "INVALID FUNCTION" is displayed.
MONO	Does not operate while GPI items are being set. If operated during the conditions described above, "INVALID FUNCTION" is displayed.

■ Operation status displayed when a FUNCTION button is used

When one of the buttons from [FUNCTION1] to [FUNCTION3] is pushed, one of the following displays is shown depending on the operation assigned to the button.

- MARKER
MARKER OFF, 4:3 MARKER, 13:9 MARKER, 14:9 MARKER, VISTA MARKER, CNSCO MARKER, 95% MARKER, 93% MARKER, 90% MARKER, 88% MARKER, 80% MARKER
- PIXEL TO PIXEL / PIXEL POSITION
CENTER, LEFT TOP, LEFT MID, LEFT BOTTOM, MID TOP, MID BOTTOM, RIGHT TOP, RIGHT MID, RIGHT BOTTOM
- FOCUS-IN-RED
FOCUS-IN-RED OFF, FOCUS-IN-RED ON
- ZEBRA
ZEBRA OFF, ZEBRA ON
- REAR TALLY
REAR TALLY OFF, REAR TALLY ON

Main Menu (continued)

■ About WFM

You can display the wave form monitor using the “WFM” function.

The display changes each time you press one of the buttons, [FUNCTION1] to [FUNCTION3] (→ page 23), assigned with the [WFM] function (To use the “WFM” function, you must assign it to one of the [FUNCTION1] to [FUNCTION3] buttons).

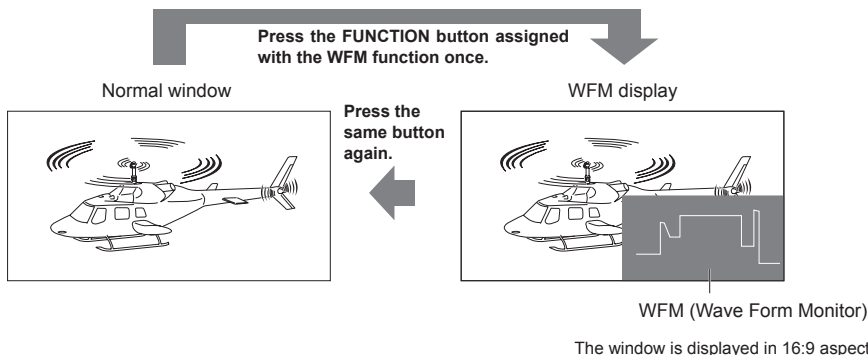

Restrictions on WFM

WFM is not displayed while using the PIXEL TO PIXEL or FOCUS-IN-RED function.

■ About PIXEL TO PIXEL and PIXEL POS. +/-

Using the “PIXEL TO PIXEL” function, you can confirm a picture with the actual pixel count (only when the input is an HD signal).

First, press one of the buttons, [FUNCTION1] to [FUNCTION3] (→ page 23), assigned with the “PIXEL TO PIXEL” function to turn it “ON”. With the function on, press another one of the buttons, [FUNCTION1] to [FUNCTION3] (→ page 23), assigned with “PIXEL POS. +” or “PIXEL POS. -”. Each time the button assigned with “PIXEL POS. +/-” is pressed, the signal display position switches.

The underlined values are factory preset setting values.

Sub menu	Settings	Explanation
PIXEL TO PIXEL	OFF ON	Used to set the display of the screen size to the input signal size.
PIXEL POS. +*1 PIXEL POS. -*1	CENTER LEFT TOP LEFT MID LEFT BOTTOM MID TOP MID BOTTOM RIGHT TOP RIGHT MID RIGHT BOTTOM	Used to set the signal display position when PIXEL TO PIXEL is on. HD signal 1080i <CENTER> center <LEFT TOP> top left <LEFT MID> Screen left center*2 <LEFT BOTTOM> bottom left <MID TOP> Screen top center*2 <MID BOTTOM> Screen bottom center*2 <RIGHT TOP> top right <RIGHT MID> Screen right center*2 <RIGHT BOTTOM> bottom right HD signal 720P <CENTER> center <LEFT TOP> top left <RIGHT TOP> top right <RIGHT BOTTOM> bottom right <LEFT BOTTOM> bottom left SD signal <CENTER> center

*1 PIXEL POS. + and – operate as follows.

*2 Refer to the next page.

Main Menu (continued)

Display position sequence during an HD signal 1080i input

PIXEL POS.+ : 1)→2)→3)→4)→5)→6)→7)→8)→9)→1) ·····
 PIXEL POS.- : 1)→9)→8)→7)→6)→5)→4)→3)→2)→1) ·····

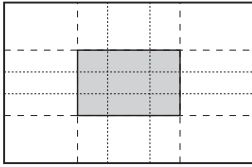

1) CENTER

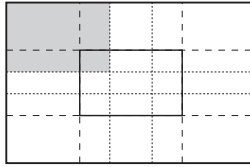

2) LEFT TOP

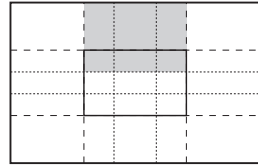

3) MID TOP

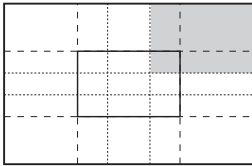

4) RIGHT TOP

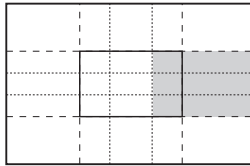

5) RIGHT MID

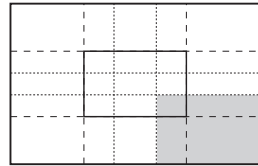

6) RIGHT BOTTOM

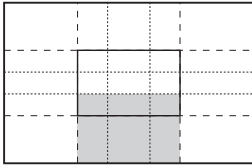

7) MID BOTTOM

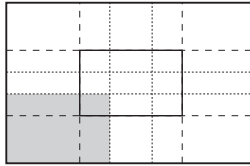

8) LEFT BOTTOM

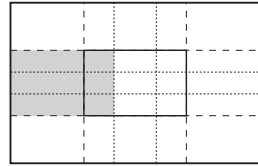

9) LEFT MID

Display position sequence during an HD signal 720P input

PIXEL POS.+ : 1)→2)→3)→4)→5)→1) ·····
 PIXEL POS.- : 1)→5)→4)→3)→2)→1) ·····

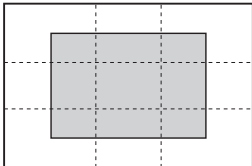

1) CENTER

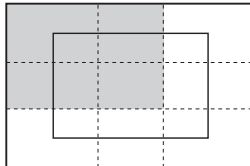

2) LEFT TOP

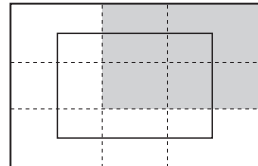

3) RIGHT TOP

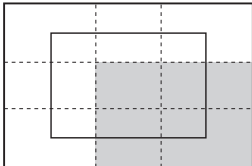

4) RIGHT BOTTOM

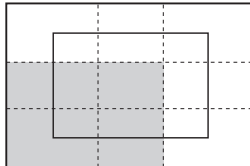

5) LEFT BOTTOM

Display position sequence during an SD signal input

The input signal is displayed in the same size but POSITION selections are not possible.*3
 Displayed in the same size even when the aspect is 16:9.

*2 The following display positions are used after the input signal format is switched from 1080i to 720P.

- 9) LEFT MID → 2) LEFT TOP
- 3) MID TOP → 1) CENTER
- 7) MID BOTTOM → 1) CENTER
- 5) RIGHT MID → 3) RIGHT TOP

*3 Displayed in the same size in the horizontal direction. The vertical direction is resized by taking into account the vertical and horizontal balance of the displayed image.

Main Menu (continued)

■ About FOCUS-IN-RED

When the FOCUS-IN-RED function is used, the section that is being focused is displayed in an easy-to-understand red, making camera focus adjustments easy.

Each time the button from [FUNCTION1] to [FUNCTION3] to which the FOCUS-IN-RED function is assigned is pushed, the display is switched (the FOCUS-IN-RED function must be assigned to one of the buttons from [FUNCTION1] to [FUNCTION3] in order to be able to use the FOCUS-IN-RED function).

When the FOCUS-IN-RED function is displayed, the detection sensitivity level (0 - 30) can be changed with the FOCUS-R knob. 30 is the most sensitive detection.

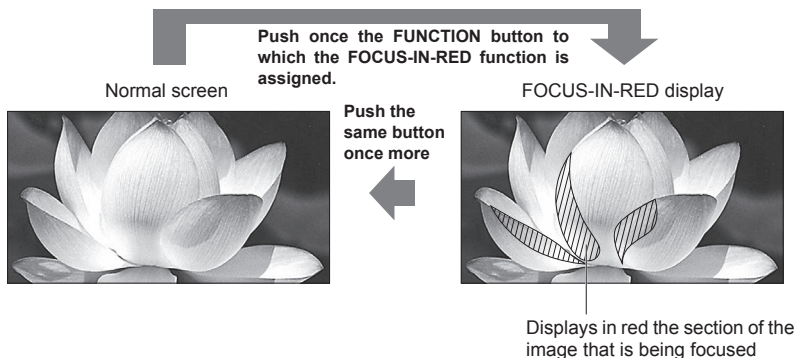

The aspect of 16:9 in the screen example.

■ About CROSS HATCH

When the CROSS HATCH function is used, markers are displayed at constant vertical and horizontal intervals in order to make it easier to decide the picture composition. The marker values are fixed at 1 dot or 1 line for the line width and 50 dots or 50 lines for the interval.

Each time the button from [FUNCTION1] to [FUNCTION3] to which the CROSS HATCH function is assigned is pushed, the display is switched.

Each time the FUNCTION button to which the CROSS HATCH function is assigned is pushed, the display is switched as follows

With HD/SD (16:9) images



Push once

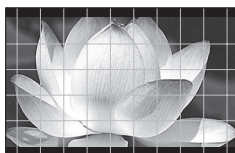

Push twice



With SD (4:3) images

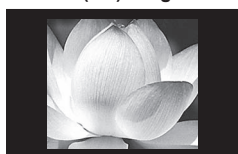

Push once

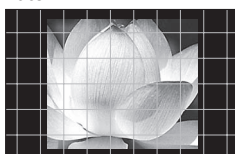

Push twice

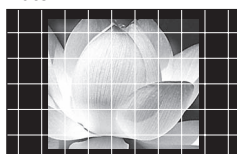

Push 3 times (returns to cross hatch display off)

Main Menu (continued)

GPI

The "GPI CONTROL" item is used to set enable/disable of all GPI functions, and assigns functions to each of the GPI terminal pins (→ page 31).

The underlined values are factory preset setting values.

Sub menu	Settings	Explanation
GPI CONTROL	<u>DISABLE</u> ENABLE	GPI functions enable/disable settings <DISABLE> Deactivate <ENABLE> Activate
GPI1 - GPI8	<u>UNDEF</u> MARKER1 ON/OFF MARKER2 ON/OFF MARKER BACK HALF MARKER BACK BLACK CENTER MARKER INPUT SEL. YP _b PR INPUT SEL. VF INPUT SEL. VIDEO INPUT SEL. SDI SD ASPECT RED TALLY GREEN TALLY MONO PIXEL TO PIXEL FOCUS IN RED	Used to set the GPI control terminal pin assign. You can set the same items for each terminal (→ page 31).

Main Menu (continued)

INPUT SELECT

The underlined values are factory preset setting values.

Sub menu	Settings	Explanation
YPbPr	<u>ON</u> OFF	Used to set the YPbPr line to the INPUT SELECT button.*1
COMPONENT LEVEL	<u>SMPTE</u> B75 B00	Used to select the input level for the YPbPr (component) signal. <SMPTE> When the signal level specified in SMPTE is Chroma 100 IRE, Pb, Pr=0.7Vp-p <B75> Select this when connecting a betacam or similar devices with a 7.5 IRE setup level. <B00> Select this when connecting a betacam or similar devices with a 0 IRE setup level.
VF	<u>ON</u> OFF	Used to set the VF line to the INPUT SELECT button.*1
VIDEO/YPbPr	<u>VIDEO</u> <u>YPbPr</u>	Used to select the VF input mode. <VIDEO> Selects the VIDEO signal. <YPbPr> Selects the YPbPr (component) signal.
SIGNAL TYPE	<u>HD</u> SD	Used to select the signal output from the camera. <HD> Selects the HD signal. <SD> Selects the SD signal.
VIDEO	<u>ON</u> OFF	Used to set the VIDEO line to the INPUT SELECT button.*1
FORMAT	<u>AUTO</u> NTSC PAL	Used to select the format for VIDEO input.*2 <AUTO> NTSC or PAL is selected automatically. <NTSC> NTSC <PAL> PAL
NTSC SETUP	<u>00</u> 75	Used to set the setup level for NTSC. <75> Select this when the signal is at a 7.5 IRE setup level. <00> Select this when the signal is at a 0 IRE setup level.
SDI	<u>ON</u> OFF	Used to set the SDI line to the INPUT SELECT button.*1*3

*1 When an SDI input unit (option) is installed, it is not possible to switch OFF all the 4 input lines. An OFF setting cannot be made for the 4th input line.

When there is no SDI input unit (option), it is not possible to switch OFF all the following 3 input lines: YPbPr, VIDEO or VF. An OFF setting cannot be made for the 3rd input line.

*2 Although the factory preset setting is AUTO, we recommend specifying a format because there is a risk of the input signal being affected by external noise.

*3 When there is no SDI input unit (option), the SDI item is displayed in gray and cannot be set.

Main Menu (continued)

CONTROL

The underlined values are factory preset setting values.

Sub menu	Settings	Explanation
CONTROL	<u>LOCAL</u> <u>REMOTE</u>	Used to select the operation. (Combined control lock) <LOCAL> Front operation enabled <REMOTE> Remote operation enabled (The front controls become locked)*1
LOCAL ENABLE	<u>DISABLE</u> <u>INPUT</u>	When "REMOTE" is selected in "CONTROL", this selects whether front controls are enabled/disabled. <DISABLE> All front operations are disabled. <INPUT> Operations other than those with the [INPUT SELECT] button are disabled.

*1 The menu can be displayed when the lock is engaged.

The only menu setting that can be changed when the lock is engaged is the "CONTROL/LOCAL ENABLE" item.

When the lock is engaged, the picture adjusting knob is disabled.

Operations when the lock is engaged follow the settings in "LOCAL ENABLE".

When the lock is engaged, the key mark is displayed on the screen.



HOURLMETER

The underlined values are factory preset setting values.

Sub menu	Settings	Explanation
OPERATION	<u>XXXXXXH</u> *1	Used to display the power distribution time.
LCD	<u>XXXXXXH</u> *1	Used to display the backlight activation time.

*1 Time is displayed in "XXXXXX".

"XXXXXX": 0 to 262,800 hours (about 30 years), "OVER" is displayed when the time exceeds 262,800 hours.

REMOTE Specifications

REMOTE operation is possible on this monitor using the GPI/RS-232C terminal.

GPI terminal

Each of the items in the GPI screen are compatible with the following terminals.

You can assign functions to each terminal in the menu GPI screen (→ page 28).

The functions assigned to each terminal operate when the GND (Pin 5) is connected (ON) or open (OFF).

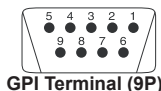

GPI Terminal (9P)

Pin number	Signal
1	GPI1
2	GPI2
3	GPI3
4	GPI4
5	GND
6	GPI5
7	GPI6
8	GPI7
9	GPI8

■ Operating conditions

Level operation: operates when GND is connected.

Edge operation: operates when GND changes from open to connected.

*If you have assigned a level operation function to more than one terminal, the function operates as long as one of the terminals is connected.

Assignment items	Function	Operating conditions
UNDEF	No settings (no terminal assignment functions)	—
MARKER1 ON/OFF*1	Switches the marker display of the marker decided in "GPI PRESET1" (→ page 17) in the "MARKER" menu.	Level operation (Connected: ON, Open: OFF)
MARKER2 ON/OFF*1	Switches the marker display of the marker decided in "GPI PRESET2" (→ page 17) in the "MARKER" menu.	Level operation (Connected: ON, Open: OFF)
MARKER BACK HALF*2	Reduces the brightness of the background outside the marker displayed in "GPI PRESET1" (→ page 17) by 50%.	Level operation (Connected: ON, Open: OFF)
MARKER BACK BLACK*2	Reduces the brightness of the background outside the marker displayed in "GPI PRESET1" (→ page 17) to 0%.	Level operation (Connected: ON, Open: OFF)
CENTER MARKER	Switches the center marker display ON/OFF. (When other markers are being displayed, this is superimposed on the other markers)	Level operation (Connected: ON, Open: OFF)
INPUT SEL. VIDEO	Switches the input line to VIDEO.	Edge operation
INPUT SEL. YPbPr	Switches the input line to YPbPr.	Edge operation
INPUT SEL. VF	Switches the input line to VF.	Edge operation
INPUT SEL. SDI	Switches the input line to SDI.	Edge operation
SD ASPECT	Sets the aspect ratio settings when using SD signal input. (Disabled when using HD signal)	Level operation (Connected: 16:9, Open: 4:3)
RED TALLY	Lights the red tally.	Level operation (Connected: ON, Open: OFF)
GREEN TALLY	Lights the green tally.	Level operation (Connected: ON, Open: OFF)
MONO	Switches between color and monochrome (MONO).	Level operation (Connected: Monochrome, Open: Color)
PIXEL TO PIXEL	Switches the screen display between input size and display size.	Level operation (Connected: ON, Open: OFF)
FOCUS-IN-RED	Displays in red the section of the image that is being focused.	Level operation (Connected: ON, Open: OFF)

*1 When the 16:9 marker and 4:3 marker are simultaneously selected and activated on the 16:9 aspect display, both markers are displayed.

*2 When the 16:9 marker and 4:3 marker are simultaneously displayed, the background selected with the 16:9 marker is controlled.

Restrictions

- SD ASPECT does not operate when the input signal is HD.
- MARKER items do not operate when the VF input line is selected.

REMOTE Specifications (continued)

■ Assignment of item priority levels

- When both "MARKER1" and "MARKER2" are ON at the same time, "MARKER1" has priority. However, when the display aspect is 4:3, the "MARKER1" aspect is 16:9, and the "MARKER2" aspect is 4:3, "MARKER2" is displayed. In this case, the "MARKER2" background is controlled.
- When "MARKER BACK HALF" and "MARKER BACK BLACK" are simultaneously activated, priority goes to "MARKER BACK BLACK".
- When two or more of the following items - "INPUT SEL. VIDEO", "INPUT SEL. VF", "INPUT SEL. SDI" and "INPUT SEL. YPbPr" - are simultaneously activated, priority goes to the last item activated.

RS-232C terminal

Refer to the following diagram and lower right table for the RS-232C terminal pin arrangement and connections. Please contact the vendor for information about detailed systems which used the RS-232C.

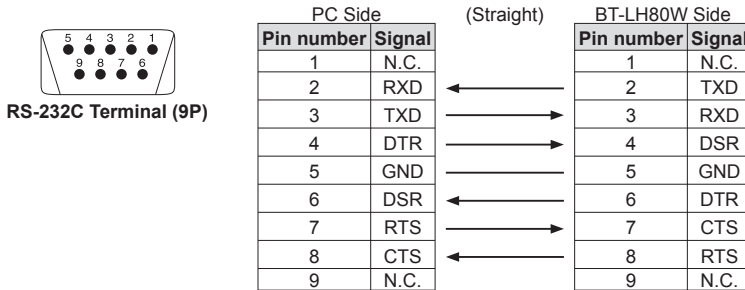

RS-232C REMOTE operation method

■ Connectors and signal names

Connector: D-SUB 9-pin (female)
Signal name

Pin number	Signal name	Explanation
1	N.C.	Not connected
2	TXD	Transmission data
3	RXD	Reception data
4	DSR	Connected inside.
5	GND	Ground
6	DTR	Connected inside.
7	CTS	Connected inside.
8	RTS	Connected inside.
9	N.C.	Not connected

■ Communication Conditions

Signal level	Conforms to RS-232C
Synchro system	Tone pace synchro system
Transfer rate	9600 bps
Parity	None
Data length	8 bit
Stop bit	1 bit
Flow control	None

■ Command format

STX(02h)	Command	:	Data	ETX(03h)
----------	---------	---	------	----------

- Commands are 3 characters following STX, finally adding ETX.
- Add a : (colon) after the command as required, and add the data.

■ Response formats

1. Setting command response

STX(02h)	Command	ETX(03h)
----------	---------	----------

2. Query command response

STX(02h)	Data	ETX(03h)
----------	------	----------

3. Error response

STX(02h)	Error code	ETX(03h)
----------	------------	----------

Error code
ER001: Invalid command
ER002: Parameter error

REMOTE Specifications (continued)

■ Setting command

No.	Command	Explanation	Data	Response
1	IIS	Input switch	0: SDI 3: YP _b P _R 2: VIDEO 5: VF	IIS
2	VPC	Image quality adjustment	CON00-60 : Contrast settings BRI00-60 : Brightness settings CRO00-60 : Chroma settings PHA00-60 : Phase settings	VPC
3	OBO	Blue only	0: OFF 1: ON	OBO
4	VBL	Backlight settings	00-60	VBL
5	DCH	Cross hatch display	0: OFF 1: LOW 2: HIGH	DCH
6	DSD	Status display	0: CONTINUE 1: 3SEC OFF 2: OFF	DSD
7	DMK	Marker settings	16:9 marker MK100 : OFF MK101 : 80% MK102 : 88% MK103 : 93% MK104 : 95% MK105 : 14:9 MK106 : 13:9 MK107 : 4:3 MK108 : 90% MK109 : CNSCO MK110 : VISTA 4:3 marker MK200 : OFF MK201 : 80% MK202 : 88% MK203 : 93% MK204 : 95% MK208 : 90% Marker background BAK0 : NORMAL BAK1: HALF BAK2: BLACK Center marker CMK0: OFF CMK1: ON	DMK
8	MCT	Color temperature settings	00: D56 01: D65 02: D93 03: VAR1 04: VAR2 05: VAR3 10-73:USER0 - 63	MCT
9	VPC	Sharpness settings	SHP0: LOW SHP1: HIGH SHH00-30: Horizontal sharpness settings SHV00-30: Vertical sharpness settings	VPC
10	MIP	IP mode settings	0: MODE1 1: MODE2	MIP
11	OMO	Monochrome settings	1: OFF 2: ON	OMO
12	MAS	SD aspect settings	0: 16:9 1: 4 :3	MAS
13	MCO	Remote settings	0: LOCAL 1: REMOTE	MCO
14	MLE	Remote operation settings	0: DISABLE 1: INPUT	MLE
15	ISM	VF mode settings	VFM0: VIDEO VFM1: YP _b P _R	ISM

REMOTE Specifications (continued)

■ Query command

No.	Command	Explanation	Data	Response
1	QIS	Input selection		0: SDI 4: VIDEO 8: VF-VIDEO 2: YP _B P _R 7: VF-Y _B P _R
2	QPC	Image quality adjustment	CON: Contrast setting value	00-60
			BRl: Brightness setting value	00-60
			CRO: Chroma setting value	00-60
			PHA: Phase setting value	00-60
3	QBO	Blue only		0: OFF 1: ON
4	QMK*1	Marker	MAK: Area marker	00: OFF 03: 93% 06: 13:9 09: CNSCO 01: 80% 04: 95% 07: 4:3 10: VISTA 02: 88% 05: 14:9 08: 90%
			BAK: Background	0: NORMAL 1: HALF 2: BLACK
			CMK: Center marker	0: OFF 1: ON
5	QCT	Color temperature		00: D56 03: VAR1 10-73: USER0 - 63 01: D65 04: VAR2 05: VAR3 02: D93
6	QPC	Sharpness	SHP: Sharpness mode	0: LOW 1: HIGH
			SHH: Horizontal sharpness value	00-30
			SHV: Vertical sharpness value	00-30
7	QPC	IP mode		0: MODE1 1: MODE2
8	QMO	Monochrome		1: OFF 2: ON
9	QAS	Aspect		0: 16:9 1: 4:3
10	QFR	Format		00: NO SIGNAL 01: 1080/60i 03: 1080/50i 10: 1080/23PsF 14: 720/59P 16: 480/60P 18: 576/50P FF: UNSUPPORT SIGNAL 02: 1080/59i 09: 1080/24PsF 13: 720/60P 15: 576/50i 17: 480/60i 23: 720/50P
11	QBL	Backlight		00-60
12	QCH	Cross hatch		0: OFF 1: LOW 2: HIGH
13	QVF	VF mode		0: VIDEO 1: YP _B P _R

*1 When the aspect ratio is 16:9, the state of 16:9 markers is returned, and when 4:3, the state of 4:3 markers is returned.

Maintenance Inspections

Maintenance inspections are necessary for the user to use this equipment safely. It is important to keep monitor functions in good condition at all times through periodical and appropriate maintenance. In order to use this monitor for a long time, and to make full use of all of its functions, be sure to carry out the following maintenance inspections.

1. Necessity of periodical maintenance services

A backlight is used in the liquid crystal panel. This part (consumable) deteriorates as time passes, and can cause performance levels to drop, or may cause a malfunction.

Therefore, in addition to the after-service repairs performed if a malfunction occurs, it is essential that general servicing and maintenance servicing are conducted on a regular basis, to prevent malfunctions and accidents caused by the deterioration of consumable parts, and to keep the monitor working normally.

2. Standard maintenance time guidelines and items to be performed

The following maintenance performance times give standard guidelines for when to perform maintenance, and do not indicate the individual lifespan of your equipment. Also, note that the deterioration time varies depending on the usage environment and way in which the equipment is used.

Part name	Quantity	Periodic maintenance inspection time
Backlight and liquid crystal panel	1	Replace every 10,000 hours*

* You cannot replace just the backlight unit on its own.

Error/Warning Displays

If for any reason an error occurs in the unit, the user is alerted of error or warning with the following displays.

Error/Warning	Display	Solution
Inverter error	All the lamps on the side of picture adjusting knobs flash at 1-second intervals.	Switch the power supply OFF once, then switch it back ON again. If an error is still displayed, contact the vendor where you purchased the unit.
Warning of improper operation status for the camera settings	ⓘ is displayed.	Check the setting values of the camera.
Battery level warning	The voltage display flashes.	Replace with a fully charged battery.
Battery level error	"END BATTERY" is displayed for approximately 3 seconds before the power supply switches OFF.	Replace with a fully charged battery.

Maintenance

- To clean the cabinet or surface of the liquid crystal protection panel, gently wipe with a soft, dry cloth. If the surfaces are extremely dirty, use a soft cloth dipped in a weak detergent solution and then wrung-out to clean the surfaces, then use a dry cloth to finish. Water or similar substances getting inside the monitor can cause a malfunction.
- Never use thinner or benzene to clean this unit. Doing so would cause the surface of the monitor to become discolored, and cause paint to peel.
- Do not spray cleansers directly onto the monitor. Water or similar substances getting inside the monitor can cause a malfunction.

Specifications

■ GENERAL

Power supply: DC 12 V (11.0 V to 17.0 V)
Input current: 1.5 A

 indicates safety information.

Dimensions (W × H × D): 218 mm × 166 mm × 64.7 mm
(8-9/16 inches × 6-9/16 inches × 2-9/16 inches)
Weight: 1.5 kg (3.3 lb)
Operating temperature: 0 °C to 40 °C (32 °F to 104 °F)
Operating humidity: 10 % to 85 % (no condensation)
Storage temperature: -20 °C to +60 °C (-4 °F to +140 °F)

■ Panel

Size: 7.9-inch V (Effective display area)
Aspect ratio: Panel: 16:9 (Effective display area)
Number of pixels: Panel: 800 × 450 (Effective display area)
Display colors: Approx. 16.77 million colors
Angle of view: Top-bottom direction: 110 ° Left-right direction: 120 °

■ Input connectors

VIDEO: 1 line, BNC × 1 (Shared with the analog component Y input terminal)
Analog component (YPbPr): 1 line, BNC × 3
(Of these, the Y input terminal is shared with the VIDEO input terminal)
SDI: 1 line, BNC × 1 (Optional)
VF: D-sub, 15 pins × 1
GPI: D-sub, 9 pins × 1
RS-232C: D-sub, 9 pins × 1

Specifications (continued)

■ List of compatible signal formats (○: Compatible, △: Limited compatibility)

Input signal formats	VIDEO	VF-VIDEO	VF-YPbPr	YPbPr	SDI*3
NTSC	○	○			
PAL	○	○			
480/59.94i			○	○	○
480/59.94P			○	○	
576/50i			○	○	○
576/50P			○	○	
720/50P			○	○	○
720/59.94P			○	○	○
720/60P			○	○	○
1035/59.94i			△*1	△*1	△*1
1035/60i			△*2	△*2	△*2
1080/23.98PsF			○	○	○
1080/24PsF			○	○	○
1080/50i			○	○	○
1080/59.94i			○	○	○
1080/60i			○	○	○

*1 When 1035/59.94i signal is input, displayed as 1080/59.94i. Other various marker displays will use the 1080/59.94i marker.

*2 When 1035/60i signal is input, displayed as 1080/60i. Other various marker displays will use the 1080/60i marker.

*3 Enabled when the separately sold BT-YA80G is installed.

Weight and dimensions are approximate.

Specifications are subject to change without notice.

Information on Disposal for Users of Waste Electrical & Electronic Equipment (private households)



This symbol on the products and/or accompanying documents means that used electrical and electronic products should not be mixed with general household waste.

For proper treatment, recovery and recycling, please take these products to designated collection points, where they will be accepted on a free of charge basis.

Alternatively, in some countries you may be able to return your products to your local retailer upon the purchase of an equivalent new product.

Disposing of this product correctly will help to save valuable resources and prevent any potential negative effects on human health and the environment which could otherwise arise from inappropriate waste handling. Please contact your local authority for further details of your nearest designated collection point.

Penalties may be applicable for incorrect disposal of this waste, in accordance with national legislation.

For business users in the European Union

If you wish to discard electrical and electronic equipment, please contact your dealer or supplier for further information.

Information on Disposal in other Countries outside the European Union

This symbol is only valid in the European Union.

If you wish to discard this product, please contact your local authorities or dealer and ask for the correct method of disposal.



This manual was printed
with soy based ink.

Panasonic[®]

Panasonic Broadcast & Television Systems Company Unit Company of Panasonic Corporation of North America

Executive Office:

One Panasonic Way 4E-7, Secaucus, NJ 07094 (201) 348-7000

EASTERN ZONE:

One Panasonic Way 4E-7, Secaucus, NJ 07094 (201) 348-7196

Southeast Region: (201) 348-7162

WESTERN ZONE:

3330 Cahuenga Blvd W., Los Angeles, CA 90068 (323) 436-3500

Government Marketing Department:

One Panasonic Way 2E-10, Secaucus, NJ 07094 (201) 348-7587

Broadcast PARTS INFORMATION & ORDERING:

9:00 a.m. – 5:00 p.m. (EST) (800) 334-4881/24 Hr. Fax (800) 334-4880

Emergency after hour parts orders (800) 334-4881

TECHNICAL SUPPORT:

Emergency 24 Hour Service (800) 222-0741

Panasonic Canada Inc.

5770 Ambler Drive, Mississauga, Ontario L4W 2T3 (905) 624-5010

Panasonic de Mexico S.A. de C.V.

Av angel Urraza Num. 1209 Col. de Valle 03100 Mexico, D.F. (52) 1 951 2127

Panasonic Puerto Rico Inc.

San Gabriel Industrial Park, 65th Infantry Ave., Km. 9.5, Carolina, Puerto Rico 00630 (787) 750-4300

Professional & Broadcast IT Systems Business Unit Europe

Panasonic AVC Systems Europe a Division of Panasonic Marketing Europe GmbH

Hagenauer Str. 43, 65203 Wiesbaden-Biebrich Deutschland Tel: 49-611-235-481